

TECHNICAL DATA : SMV 25-1200C

Machine type		SMV 25-1200C
LOAD HANDLING DATA		
Lifting capacity / Load center	kg / mm	25 000 / 1200
Maximum lifting speed, unloaded / at 70% of rated load	m/s	0,32 / 0,30
Maximum lowering speed, unloaded / at rated load	m/s	0,38 / 0,40
DRIVING DATA		
Drive speed forward, unloaded / at rated load	km/h	26 / 25
Drive speed reverse, unloaded / at rated load	km/h	26 / 25
Incline (driving ability) at rated load at 0 km/h / at 2 km/h	%	44 / 35
Towing (power ability) at rated load at 0 km/h / at 2 km/h	kN	246 / 203
SERVICE WEIGHT / AXLE LOADS		
Service weight	kg	34 100
Axle load front, unloaded / at rated load	kg	16 700 / 55 100
Axle load rear, unloaded / at rated load	kg	17 400 / 4 000
ENGINE		
Engine make, model name		Volvo TAD881-VE
Emission approval EU / US		Stage V
Monitoring / emission controlled / CanBus		Yes / yes / yes
Fuel / type of engine		Diesel / 4-stroke CI
Rated power ISO 3046 / max speed	kW / rpm	185 / 2 200
Rated torque ISO 3046 / at speed	Nm / rpm	1 175 / 1 400
Displacement / No. of cylinders / configuration	L / /	7,7 / 6 / Inline
Fuel consumption, normal operations	L/h	8-12
Alternator, type / power / amperage	W / Amp	AC / 3 080 / 110
Starting battery, voltage / capacity	V / Ah	2 x 12 / 140
TRANSMISSION		
Transmission make, model name		ZF 191WG
Monitoring / reverse protection / CanBus		Yes / yes / yes
Clutch, type		Torque converter
Transmission type / type of shift gear		Softshift – Powershift / Automatic
No. of gears, forward/reverse		3/3
DRIVE AXLE & STEER SYSTEM		
Drive axle make, model name		Kessler D81
Drive axle type		Differential + hub reduction
Service brake, type / affected wheels		Oil cooled Wet Disc Brakes / drive wheels
Parking brake, type / affected wheels		Dry disc brake / spring applied / drive wheels
STEER AXLE & STEER SYSTEM		
Steer axle make / type		Konecranes / double acting single cylinder
Steering system		Hydraulic servo assisted / power steering
WHEELS		
Number of wheels, front+rear / Type (*driven)		4*+2 / pneumatic
Tire pressure front / rear	MPa	1,0 / 1,0
Tire dimensions (Ply rating) front / rear	Inch (No)	14.00 x 24" (PR 24) / 14.00 x 24" (PR 24)
Rim dimension front / rear	Inch	10.00 x 24" / 10.00 x 24"
HYDRAULIC SYSTEM		
Hydraulic pump make, model name		Parker P2-series
Hydraulic system / pump type		Load sensing system / variable axial piston pump
Power-on-demand / Low energy		Yes / yes
Hydraulic oil pressure mast	MPa	24,0
TANK VOLUMES		
Fuel tank volume	L	339
Hydraulic tank volume	L	312
LIFTING EQUIPMENT		
Lift mast model / mast type / design		Konecranes duplex standard / 2-stage / free visibility
Carriage make / model		Konecranes / Hydraulic integral roller type
Fork make / Model		Konecranes / Roller type
OTHERS		
Noise level (inside Cab / Lm) DIN 45635	dB(A)	67
Noise level (inside Cab/ LpAZ) EN 12053 (EU + EFTA only)	dB(A)	73
Maximum noise level (outside Lwa) 2000/14/EC (EU + EFTA only)	LWA	107
NORMS & STANDARDS		
Stability of Industrial Trucks ISO 22915-2		Yes
Safety of Industrial Trucks EN ISO 3691-1		Yes

TECHNICAL DATA : SMV 25-1200C

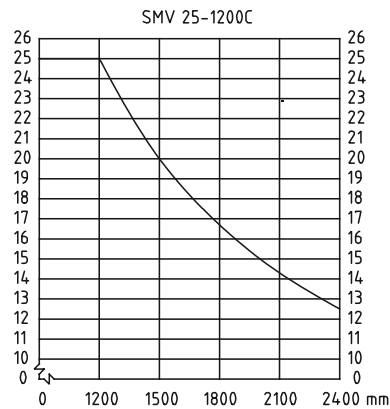
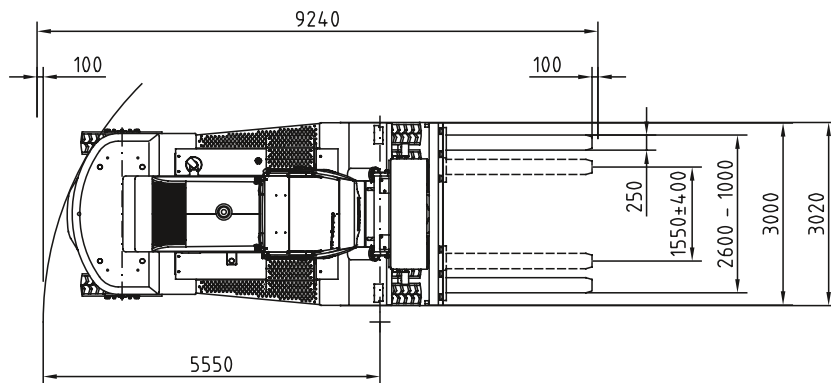
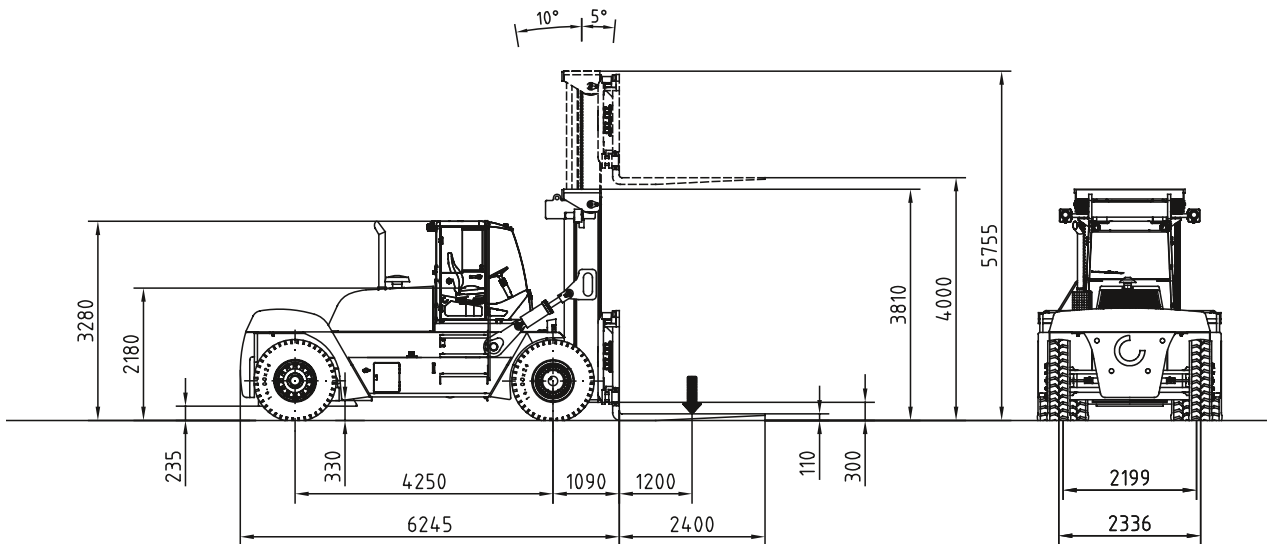

191116 / 1