

REACH STACKER SMV 4628 TC6

LIFTING DATA			
Lift capacities (at load center LC1 / LC2 / LC3)	46000 kg / 28000 kg / 14500 kg		
Lift capacities (at load center LC1 / LC2 / LC3 at max lifting height)	39000 kg / 23000 kg / 14500 kg		
Load centers (LC1 / LC2 / LC3)	2200 mm / 3850 mm / 6350 mm		
Lifting speed, unloaded / at 40 % load / at 70% rated load	0.38 m/s / 0.35 m/s / 0.23m/s		
Lowering speed, unloaded / at rated load	0.35 m/s / 0.40 m/s		
DRIVING DATA			
Drive speed forward, unloaded / at rated load	24 km/h / 21 km/h		
Drive speed reverse, unloaded / at rated load	18 km/h / 17 km/h		
Incline (driving ability) at rated load at 0 km/h / 2 km/h	25 % / 20 %		
Towing (power ability) at rated load at 0 km/h / 2 km/h	300 kN/ 246 kN		
SERVICE WEIGHT / AXLE PRESSURE			
Service weight	68100 kg		
Axle pressure front at load center LC1, unloaded / at rated load	36200 kg / 103800 kg		
Axle pressure front at load center LC2, unloaded / at rated load	40000 kg / 88400 kg		
Axle pressure rear at load center LC1, unloaded / at rated load	31900 kg / 10300 kg		
Axle pressure rear at load center LC2, unloaded / at rated load	28100 kg / 7700 kg		
Axle pressure in driving position, front/rear (at rated load)	92300 kg / 21800 kg		
ENGINE (ELECTRONIC CONTROLLED)			
Engine make / model name	Volvo TAD-1181-VE	Torque ISO 3046 / at speed	1785 Nm / 1400 rpm
Emission approval EU / US	EU 5	Displacement / No. of cyl. / type	11 l / 6 / Inline
Monitoring / EC / CanBus	Yes / Yes / Yes	Fuel consumption, normal usage	15 - 18 l/h
Fuel / type of engine / intercooler	Diesel / 4-stroke / Yes	Alternator, type/power / capacity	AC / 3080 W / 110 A
Power ISO 3046 / max speed	265 kW / 2100 rpm	Start battery, voltage/capacity	2 x 12 V / 140 Ah
TRANSMISSION (ELECTRONIC CONTROLLED)			
Transmission make / model / amount of gears (forward /reverse)	Dana TE-30 / 5 + 3 gears		
Monitoring / reverse protection / CanBus / Clutch, type	Yes / Yes / Yes / Torque converter		
Transmission type / type of shift gear	Softshift – Powershift / Automatic		
STEERING AXLE & STEERSYSTEM & DRIVE AXLE & BRAKE SYSTEM			
Steer axle type / steering system	Double acting cylinder / hydraulic servo assisted		
Drive axle make / model name	Kessler D102		
Drive axle type / drive axle width	Differential + hub reduction / 4160 mm		
Driving brake system, type / affected wheels	Oil cooled Wet Disc Brakes / drive wheels		
Parking brake system, type / affected wheels	Dry disc brake / spring release / drive wheels		
WHEELS			
Number of wheels, front + rear / type (*driven)	4*+2 / pneumatic		
Tire pressure front / rear	1.00 MPa / 1.00 MPa		
Tire dimensions (Ply rating) front / rear	18.00 x 25" (PR 40) / 18.00 x 25" (PR 40)		
Rim dimension front / rear	13.00 x 25" / 13.00 x 25"		
HYDRAULIC SYSTEM			
Hydraulic pump make / model name	Parker & Hannifin / P2-series		
Hydraulic system / pump type	Load sensing system / variable piston pump		
Power-on-demand / Low energy / Separate oil tanks	Yes / Yes / Yes (hydraulics & brakes)		
Hydraulic oil pressure mast / spreader	24 MPa / 15 MPa		
TANK VOLUMES			
Diesel tank volume	650 l	Hydraulic tank volume	850 l
LIFTING EQUIPMENT & SPREADER			
Spreader make / type	ELME 817-MPS / Toplift (container)		
Spreader functions	20-40 ft containers		
Spreader locking containers + trailer / lifting eyes	4 x top twist locks / 4x in the corners		
Sideshift stroke / rotation / pile slope type (pile slope stroke)	±800 mm / +195 mm: -105 Manual MPS (± 2 deg)		
NORMS & STANDARDS		OTHERS	
Machine Directive in Europe	2006/42/EC	Noise level (inside Cab/ LpAZ)	EN 12053 75 dB(A)
Stability of Industrial Trucks	ISO22915 series / EN15000	Noise level (outside at 7 m/ Lwa)	2000/14/EC 111 dB(A)
Safety of Industrial trucks	ISO 3691-2	Safety, Monitoring & overload system / programmable / colour	Electronic system EMC / Yes / Yes
Noise level (inside Cab / Lm)	DIN 45635 68 dB(A)	Manual sliding cabin / stroke	Yes / (Stepless)

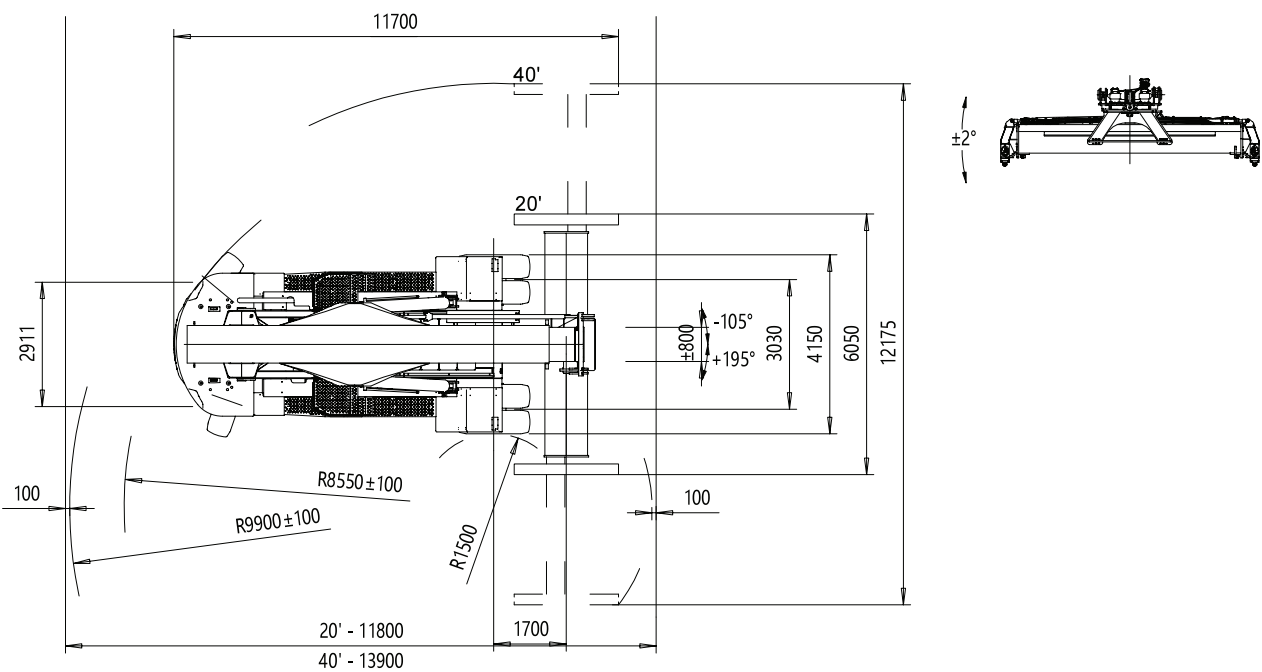
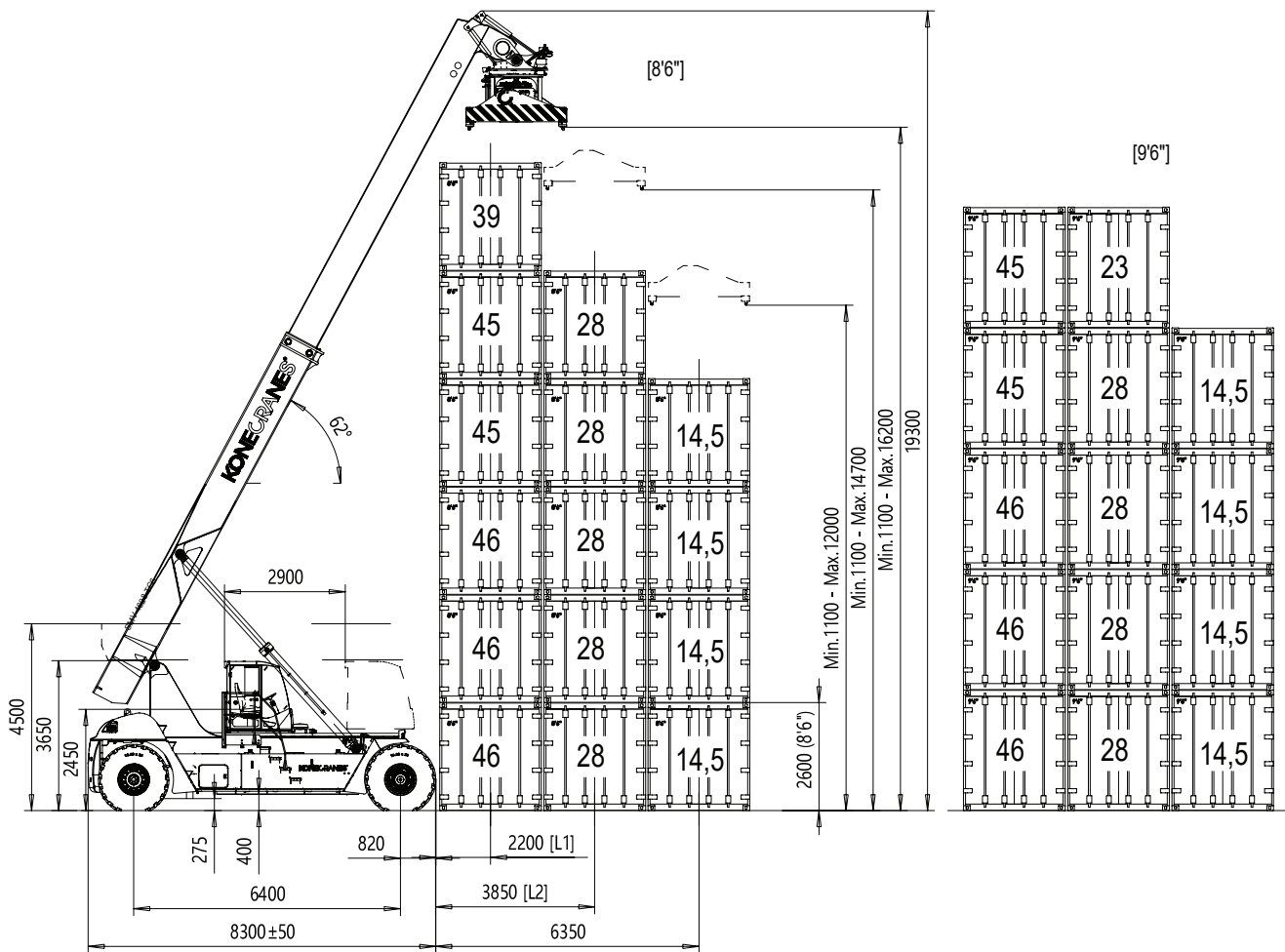

191121/ 1