

TECHNICAL DATA : LIFTACE F12-600C

Machine type		F12-600C
LOAD HANDLING DATA		
Lifting capacity / Load center	kg / mm	12 000 / 600
Maximum lifting speed, unloaded / at 70% of rated load	m/s	0,46 / 0,44
Maximum lowering speed, unloaded / at rated load	m/s	0,51 / 0,58
DRIVING DATA		
Drive speed forward, unloaded / at rated load	km/h	27 / 26
Drive speed reverse, unloaded / at rated load	km/h	27 / 26
Incline (driving ability) at rated load at 0 km/h / at 2 km/h	%	27 / 21
Towing (power ability) at rated load at 0 km/h / at 2 km/h	kN	89 / 78
SERVICE WEIGHT / AXLE LOADS		
Service weight	kg	15 000
Axle load front, unloaded / at rated load	kg	7 600 / 25 300
Axle load rear, unloaded / at rated load	kg	7 400 / 1 700
ENGINE		
Engine make, model name		Volvo TAD571-VE
Emission approval EU / US		Stage IV / Tier 4 Final
Monitoring / emission controlled / CanBus		Yes / yes / yes
Fuel / type of engine		Diesel / 4-stroke CI
Rated power ISO 3046 / max speed	kW / rpm	129 / 2 300
Rated torque ISO 3046 / at speed	Nm / rpm	810 / 1 400
Displacement / No. of cylinders / configuration	L / /	5.1 / 4 / Inline
Fuel consumption, normal operations	L/h	5-7
Alternator, type / power / amperage	W / Amp	AC / 3 080 / 110
Starting battery, voltage / capacity	V / Ah	2 x 12 / 100
TRANSMISSION		
Transmission make, model name		DANA TE-10
Monitoring / reverse protection / CanBus		Yes / yes / yes
Clutch, type		Torque converter
Transmission type / type of shift gear		Softshift – Powershift / Automatic
No. of gears, forward/reverse		3/3
DRIVE AXLE & STEER SYSTEM		
Drive axle make, model name		Kessler D81
Drive axle type		Differential + hub reduction
Service brake, type / affected wheels		Oil cooled Wet Disc Brakes / drive wheels
Parking brake, type / affected wheels		Dry disc brake / spring applied / drive wheels
STEER AXLE & STEER SYSTEM		
Steer axle make / type		Konecranes / double acting single cylinder
Steering system		Hydraulic servo assisted / power steering
WHEELS		
Number of wheels, front+rear / Type (*driven)		4*+2 / pneumatic
Tire pressure front / rear	MPa	1,0 / 1,0
Tire dimensions (Ply rating) front / rear	Inch (No)	11.00 x 20" (PR 20) / 11.00 x 20" (PR 20)
Rim dimension front / rear	Inch	8.00 x 20" / 8.00 x 20"
HYDRAULIC SYSTEM		
Hydraulic pump make, model name		Parker P2-series
Hydraulic system / pump type		Load sensing system / variable axial piston pump
Power-on-demand / Low energy		Yes / yes
Hydraulic oil pressure mast	MPa	26,5
TANK VOLUMES		
Fuel tank volume	L	136
Hydraulic tank volume	L	115
LIFTING EQUIPMENT		
Lift mast model / mast type / design		Konecranes duplex standard / 2-stage / free visibility
Carriage make / model		Konecranes / Hydraulic integral roller type
Fork make / Model		Konecranes / Roller type
OTHERS		
Noise level (inside Cab / Lm) DIN 45635	dB(A)	65
Noise level (inside Cab/ LpAZ) EN 12053 (EU + EFTA only)	dB(A)	73
Maximum noise level (outside Lwa) 2000/14/EC (EU + EFTA only)	LWA	105
NORMS & STANDARDS		
Stability of Industrial Trucks ISO 22915-2		Yes
Safety of Industrial Trucks EN ISO 3691-1		Yes

TECHNICAL DATA : LIFTACE F12-600C

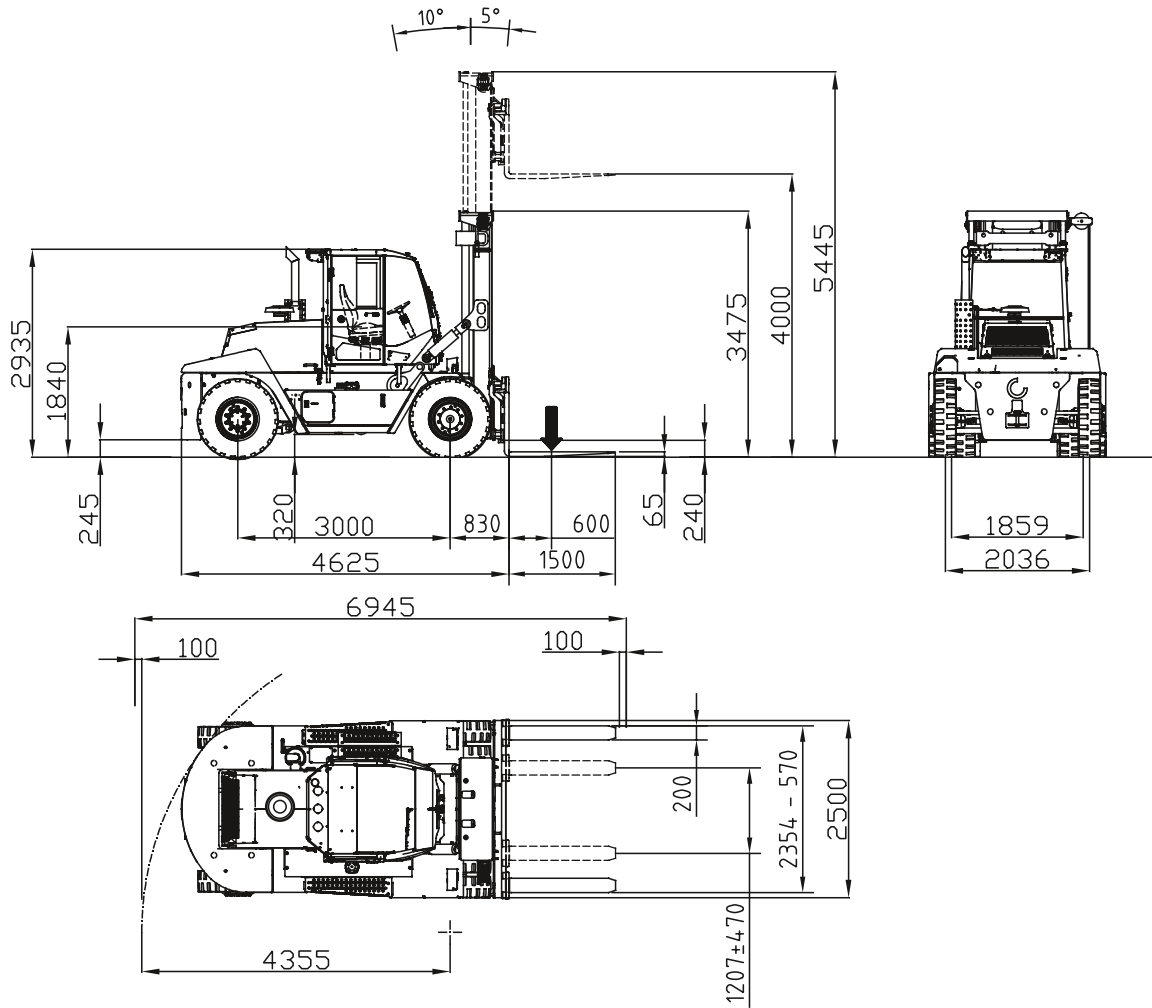

F 12-600C

