

Features

Linde compact drive axle

- Twin drive design with high performance Linde AC technology
- Optimum energy efficiency
- Maintenance-free oil-bath vane brake
- Automatic parking brake
- Electronic components housed in sealed unit for complete protection



Linde hydrostatic power steering

- Minimal physical demands on the operator
- Compact ergonomically designed steering wheel
- Linde combi steer axle for outstanding manoeuvrability

Linde twin accelerator control

- Seamless, rapid reversing without repositioning the feet
- Short pedal travel
- Fatigue-free working
- Increased throughput and performance

Linde Load Control

- Small tactile joystick integrated in an adjustable armrest
- Precise and effortless fingertip joystick control of all mast functions
- Safe and highly efficient load handling

Linde Dual Motor Drive

- Two powerful AC drive motors integrated in the front axle
- Seamless acceleration and variable torque characteristics
- Extremely quiet in operation



Linde operator's compartment

- Ergonomically designed for efficient, fatigue-free working
- Spacious operator's compartment with generous floor plate area
- Cushioned comfort – mast and drive axle are isolated from the chassis and cab by a unique resilient suspension system that absorbs shock loadings



Linde clearview mast design

- with top mounted tilt cylinders for seamless load control and stability
- Excellent view of load and surroundings through the robust yet slim mast profiles
- Nominal capacity retained to maximum lift heights
- High residual capacities in all applications



Linde energy management

- Optimised energy consumption
- Accurate battery condition indicator
- Simple horizontal or vertical battery changing options
- Optional built-in high frequency charger for convenience and flexibility
- Record of battery usage

Subject to modification in the interests of progress. Illustrations and technical details not binding for actual constructions. All dimensions subject to usual tolerances.

Printed in Denmark: TruckTryk 99 83 83 94



Electric Counterbalanced Trucks
Capacity 2000 - 3500 kg
E20, E25, E30, E35
Series 387

Safety

The protective overhead guard forms a strong and completely enclosed protective zone providing optimum structural integrity, safety and protection for the operator. The top mounted tilt cylinders provide seamless, smooth control of the tilt movements for excellent load stability in all operating conditions. This unique design also enables slimmer mast profiles to be fitted for outstanding visibility.

Performance

One would expect a high performance truck to have a high performance traction system – and that is exactly what the Linde compact drive axle and lift system delivers. Powerful motors and intelligent electronic control form an impressive power pack to deliver the highest level of productivity.

Comfort

Consistently high levels of performance and efficiency for extended periods are only possible if the operator feels comfortable. The ergonomic layout of all the controls, the adjustability of the armrest and seat, Linde Load Control, and twin accelerator pedals provide the best possible intuitive interface between the truck and the operator.

Reliability

An electric forklift truck depends on reliable electronic systems. The Linde electronic control system provides a high level of reliability because of its dual circuit monitoring system and the sealed aluminium housing which provides total protection for the electronics from the ingress of dust and moisture.

Productivity

Effective in operation, efficient in reducing costs: The unique Linde energy management system ensures intelligent and economical consumption of energy. Energy can also be obtained quickly utilising the optional built-in charging unit or one of the four simple and rapid battery changing methods. The result: more uptime and increased productivity.

ncnielsen

Nørregade 66
7860 Balling

Telefon 99 83 83 83 • fax 97 56 46 24
www.nc-nielsen.dk • linde@nc-nielsen.dk



E20

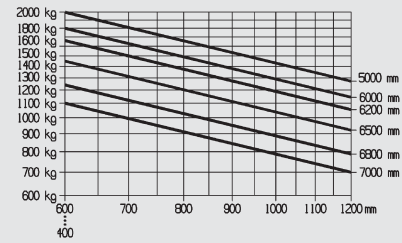

E20/600H

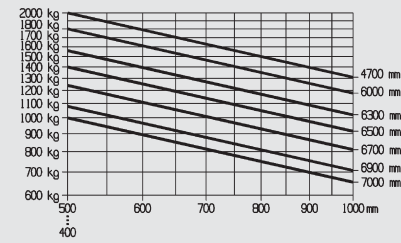

E25

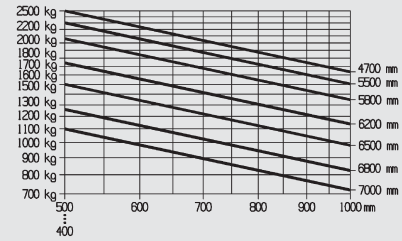

E25/600H

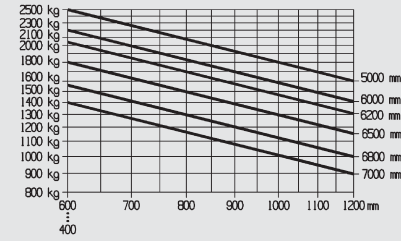

E25L

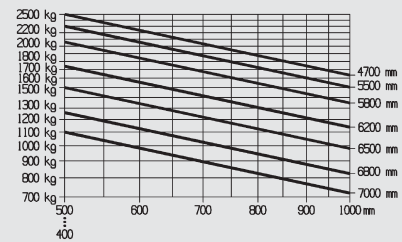

E25/600HL

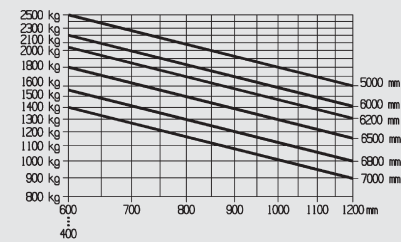

E30

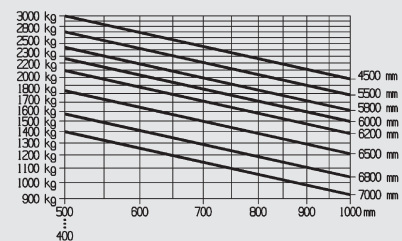

E30/600H

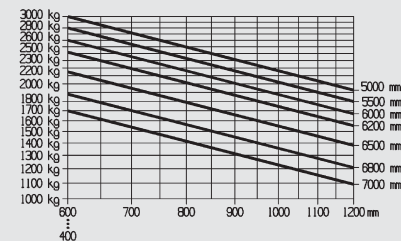

E30L

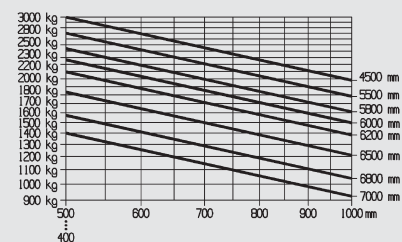

E30/600HL

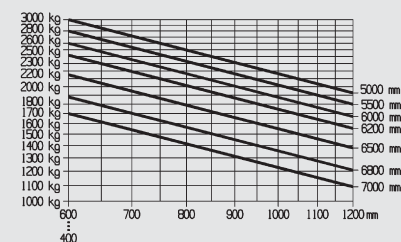

E35L

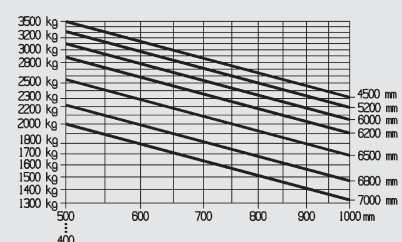

E35HL

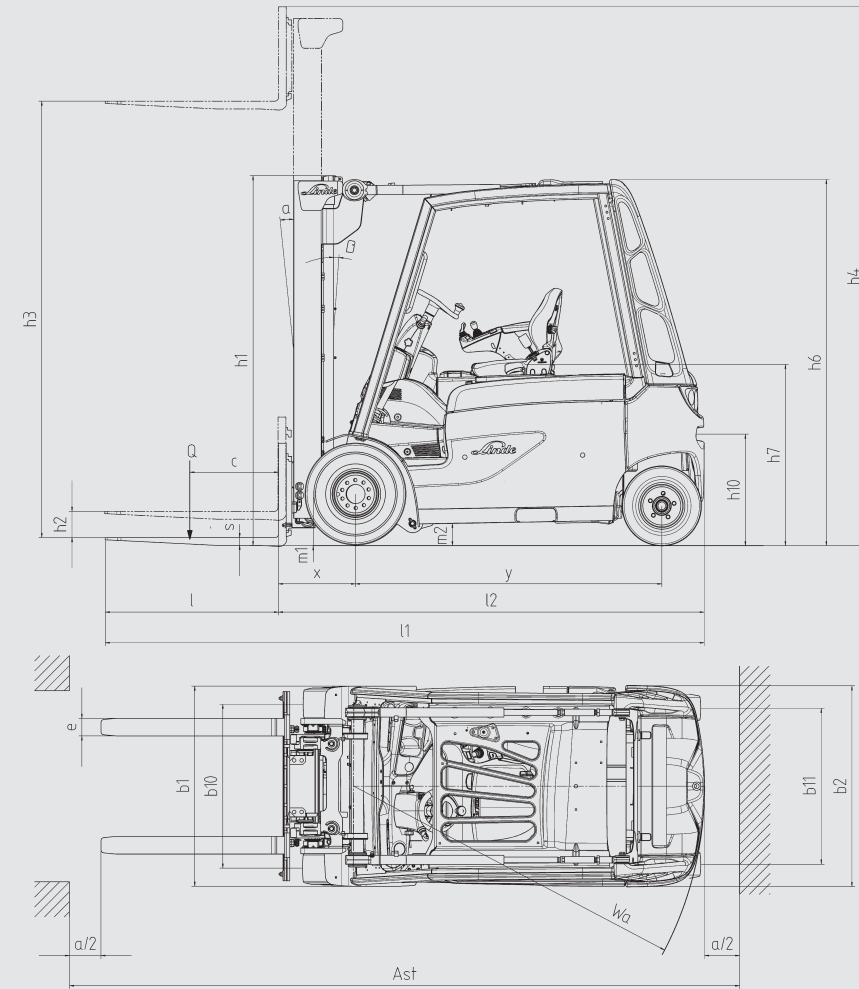
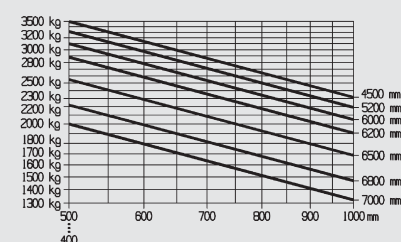

Standard mast		E20 E25 E25L	E20 E20-600H E25 E25L				E30 E30L E35L	E25-600H / E25-600HL E30 / E30L E30-600H / E30-600HL E35L / E35HL				
Lift	h3	3150	3450	3750	4050	4550	3050	3200	3650	4050	4450	4950
Mast retracted *	h1	2247	2397	2547	2697	2947	2225	2300	2524	2724	2924	3174
Mast extended	h4	3813	4113	4413	4713	5213	3828	3978	4428	4828	5228	5728
Free lift	h2	150	150	150	150	150	150	150	150	150	150	150

Duplex mast		E20 E25 E25L	E20 E20-600H E25 E25L	E30 E30L E35L	E25-600H / E25-600HL E30 / E30L E30-600H / E30-600HL E35L / E35HL		
Lift	h3	3170	3770	2925	3215	3765	4065
Mast retracted	h1	2174	2474	2081	2226	2501	2651
Mast extended	h4	3832	4432	3652	3942	4442	4742
Free lift	h2	1511	1811	1274	1424	1674	1824

Triplex mast		E20 E25 E25L	E20 E20-600H E25 E25L			E30 E30L E35L	E25-600H / E25-600HL E30 / E30L E30-600H / E30-600HL E35L / E35HL					
Lift	h3	4715	4865	5165	5515	5965	6465	4350	4780	5355	5955	6455
Mast retracted	h1	2174	2224	2324	2474	2624	2824	2074	2224	2449	2649	2849
Mast extended	h4	5378	5528	5828	6178	6628	7128	5125	5555	6130	6730	7230
Free lift	h2	1511	1561	1661	1811	1961	2161	1299	1449	1674	1874	2074

Figures in mm
Figures for other equipments and triplex masts on request

Technical Data according to VDI 2198

			Model designation			
			E25/600HL	E30/600HL	E35HL	
Characteristics	1.1	Manufacturer	LINDE	LINDE	LINDE	
	1.2	Model designation	E25/600HL	E30/600HL	E35HL	
	1.3	Power unit	Battery	Battery	Battery	
	1.4	Operation	Seat	Seat	Seat	
	1.5	Load capacity	Q (t)	2.5	3.0	3.5
	1.6	Load centre	c (mm)	600	600	500
	1.8	Axle centre to fork face	x (mm)	468	476	476
	1.9	Wheelbase	y (mm)	1796	1796	1796
	Weights	2.1	Service weight	(kg)	5445 ¹⁾	5830 ¹⁾
2.2		Axle load with load, front/rear	(kg)	7057 / 888	7937 / 893	8547 / 938
2.3		Axle load without load, front/rear	(kg)	3070 / 2375 ¹⁾	3140 / 2690 ¹⁾	3145 / 2840 ¹⁾
Wheels/Tyres	3.1	Tyres rubber, SE, pneumatic, polyurethane		SE	SE	SE
	3.2	Tyre size, front		225/75-10 (23x9-10)	250/60-12(23x10-12)	315/45-12
	3.3	Tyre size, rear		180/60-10	200/50-10	200/50-10
	3.5	Wheels, number front/rear (x = driven)		2x / 2	2x / 2	2x / 2
	3.6	Track width, front	b10 (mm)	942	980	1028
	3.7	Track width, rear	b11 (mm)	900	886	886
	Dimensions	4.1	Mast/fork carriage tilt, forward/backward	a/b (°)	5.0 / 8.0	5.0 / 8.0
4.2		Height of mast, lowered	h1 (mm)	2297	2299	2295
4.3		Free lift	h2 (mm)	150	150	150
4.4		Lift	h3 (mm)	3200	3200	3200
4.5		Height of mast, extended	h4 (mm)	3975	3977	3973
4.7		Height of overhead guard (cabin)	h6 (mm)	2237	2237	2237
4.8		Height of seat/stand-on platform	h7 (mm)	1160	1160	1160
4.12		Towing coupling height	h10 (mm)	659	661	659
4.19		Overall length	l1 (mm)	3520	3528	3528
4.20		Length to fork face	l2 (mm)	2520	2528	2528
4.21		Overall width	b1/b2 (mm)	1150 / 1146	1228 / 1146	1322 / 1146
4.22		Fork dimensions	s/e/l (mm)	45 x 100 x 1000	50 x 120 x 1000	50 x 120 x 1000
4.23		Fork carriage to ISO 2328, class/type A, B		2A	3A	3A
4.24		Width of fork carriage	b3 (mm)	1150	1150	1150
4.31		Ground clearance, below mast	m1 (mm)	127	136	129
4.32		Ground clearance, centre of wheelbase	m2 (mm)	120	120	120
4.33		Aisle width with pallet 1000 x 1200 across forks	Ast (mm)	3838 ²⁾	3845 ²⁾	3845 ²⁾
4.34		Aisle width with pallet 800 x 1200 along forks	Ast (mm)	3967 ²⁾	3975 ²⁾	3975 ²⁾
4.35		Turning radius	Wa (mm)	2052	2052	2052
4.36	Minimum pivoting point distance	b13 (mm)	0	0	0	
Performance	5.1	Travel speed, with/without load	(km/h)	20 / 20	20 / 20	20 / 20
	5.2	Lifting speed, with/without load	(m/s)	0.44 / 0.53	0.42 / 0.51	0.39 / 0.51
	5.3	Lowering speed, with/without load	(m/s)	0.56 / 0.56	0.56 / 0.56	0.56 / 0.56
	5.5	Tractive force, with/without load	(N)	4600 / 4600	4600 / 4600	4600 / 4600
	5.6	Maximum tractive force, with/without load	(N)	15000 / 15000	15000 / 15000	15000 / 15000
	5.7	Climbing ability, with/without load	(%)	5.9 / 8.6	5.3 / 8.1	4.9 / 7.9
	5.8	Maximum climbing ability, with/without load	(%)	19.6 / 29.3	17.6 / 27.2	16.3 / 26.4
	5.9	Acceleration time, with/without load	(s)	upon request	upon request	upon request
	5.10	Service brake		hydr./mech.	hydr./mech.	hydr./mech.
	Drive	6.1	Drive motor, 60 minute rating	(kW)	2x 9	2x 9
6.2		Lift motor rating at S3 15%	(kW)	22	22	22
6.3		Battery according to DIN 43531/35/36 A,B,C,no		43 536 / A	43 536 / A	43 536 / A
6.4		Battery voltage/rated capacity (5h)	(V/Ah)	80 / 700-775	80 / 700-775	80 / 700-775
6.5		Battery weight (± 5%)	(kg)	1863	1863	1863
6.6		Power consumption according to VDI cycle	(kWh/h)	7,9	8,7	9,8
Others	8.1	Type of drive control		Digital/stepless	Digital/stepless	Digital/stepless
	8.2	Operating pressure for attachments	(bar)	170	170	170
	8.3	Oil flow for attachments	(l/min)	50	50	50
	8.4	Noise level at operator's ear	(dB(A))	<65.0	<65.0	<65.0

1) Figures with battery, see line 6.4/6.5.

2) Including a 200 mm (min.) operating aisle clearance.

Standard Equipment/Optional Equipment

Standard Equipment

Hydrostatic power steering
 Linde twin accelerator pedals for all vehicle movements
 Central lever (joystick control) integrated into the adjustable armrest
 2 x 9 kW maintenance free AC drive motors
 22 kW AC maintenance free lift motor
 Different ECO modes providing the perfect combination of performance and efficiency
 Graphic display of battery operating time in minutes
 Automatic parking brake
 Linde patented combi axle in all models up to 3.5 t.
 Linde dual motor drive
 Proportional reduction of travel speed when cornering (Linde Drive Assistant)
 Seamless electronic control of all traction and hydraulic movements
 Standard chassis suitable for working in ISO containers with appropriate mast
 Hydraulically adjustable full suspension PVC operator's seat with armrest
 Comprehensive digital instrument display
 Generous storage facilities for writing materials and miscellaneous items
 Superelastic tyres

Mast

Clearview standard mast 3,110 mm lift
 Fork carriage width:
 1,080 mm for E20, E20/600H, E25, E25L
 1,150 mm for E25/600H, E25/600HL, E30, E30/600 H, E30/600 HL, E30 L, E35 L, E35 HL
 Fork length 1,000 mm

Optional Equipment

Single pedal accelerator with forward/reverse selector in the armrest
 Standard mast lifts up to 5,450 mm
 Duplex mast lifts (full free lift) up to 4,270 mm with 2 t. truck
 Triplex mast lifts (full free lift) up to 6,465 mm with 2 t. truck
 Alternative fork lengths
 Alternative fork carriage widths
 Integrated sideshift
 Integrated fork spreader
 Tilt cylinder protection
 Load backrest
 One, two or three additional hydraulic circuits for attachments
 Polycarbonate top screen on overhead guard
 Front and rear screens, wipers and tops screen
 Full cab with hinged doors
 Overhead guard sun blinds (front + top)
 Heating (with pollen protection filter)
 Radio with CD player
 Fabric covered comfort seat
 Super-comfort seat with air suspension, heater and backrest extension
 Swivelling seat
 Integrated charger unit, optionally with electrolytic circulation
 Individual or single hydraulic control joystick
 Working lamps with LED technology
 Truck lighting with LED technology (only rear lights)
 Full road lighting

Flashing beacon/rotating beacon
 Audible reversing alarm
 External, internal and panoramic mirror
 Clipboard with LED illumination
 Cold store protection
 Active ventilation for battery charging
 Alternative custom paintwork
 Linde Fleet Management (LFM)
 Alternative tyre types
 Electrical socket 12 V

Other options available on request

Technical Data according to VDI 2198

Characteristics	1.1	Manufacturer		LINDE	LINDE	LINDE	LINDE	LINDE	LINDE	LINDE	LINDE	LINDE
	1.2	Model designation		E20	E25	E30	E20/600H	E25/600H	E30/600H	E25L	E30L	E35L
	1.3	Power unit		Battery	Battery	Battery	Battery	Battery	Battery	Battery	Battery	Battery
	1.4	Operation		Seat	Seat	Seat	Seat	Seat	Seat	Seat	Seat	Seat
	1.5	Load capacity	Q (t)	2.0	2.5	3.0	2.0	2.5	3.0	2.5	3.0	3.5
	1.6	Load centre	c (mm)	500	500	500	600	600	600	500	500	500
	1.8	Axle centre to fork face	x (mm)	445	445	471	445	468	476	445	471	476
	1.9	Wheelbase	y (mm)	1622	1622	1665	1651	1651	1651	1767	1767	1810
	Weights	2.1	Service weight	(kg)	4210 ¹⁾	4654 ¹⁾	5325 ¹⁾	4825 ¹⁾	5430 ¹⁾	5870 ¹⁾	4585 ¹⁾	5365 ¹⁾
2.2		Axle load with load, front/rear	(kg)	5615 / 595	6401 / 753	7560 / 765	5886 / 939	7082 / 848	8000 / 870	6412 / 673	7564 / 801	8422 / 783
2.3		Axle load without load, front/rear	(kg)	2450 / 1760 ¹⁾	2444 / 2210 ¹⁾	2810 / 2515 ¹⁾	2620 / 2205 ¹⁾	2965 / 2465 ¹⁾	3045 / 2825 ¹⁾	2575 / 2010 ¹⁾	2915 / 2450 ¹⁾	3035 / 2670 ¹⁾
Wheels/Tyres	3.1	Tyres rubber, SE, pneumatic, polyurethane		SE	SE	SE	SE	SE	SE	SE	SE	SE
	3.2	Tyre size, front		225/75-10 (23x9-10)	225/75-10 (23x9-10)	225/75-10 (23x9-10)	225/75-10 (23x9-10)	225/75-10 (23x9-10)	250/60-12(23x10-12)	225/75-10 (23x9-10)	225/75-10 (23x9-10)	315/45-12
	3.3	Tyre size, rear		180/70-8 (18x7-8)	180/60-10	200/50-10	180/70-8 (18x7-8)	180/60-10	200/50-10	180/60-10	200/50-10	200/50-10
	3.5	Wheels, number front/rear (x = driven)		2x / 2	2x / 2	2x / 2	2x / 2	2x / 2	2x / 2	2x / 2	2x / 2	2x / 2
	3.6	Track width, front	b10 (mm)	942	942	942	942	942	980	942	942	1028
	3.7	Track width, rear	b11 (mm)	900	900	886	900	900	886	900	886	886
	Dimensions	4.1	Mast/fork carriage tilt, forward/backward	a/b (°)	5.0 / 8.0	5.0 / 8.0	5.0 / 8.0	5.0 / 8.0	5.0 / 8.0	5.0 / 8.0	5.0 / 8.0	5.0 / 8.0
4.2		Height of mast, lowered	h1 (mm)	2247	2247	2223	2397	2297	2300	2247	2222	2220
4.3		Free lift	h2 (mm)	150	150	150	150	150	150	150	150	150
4.4		Lift	h3 (mm)	3150	3150	3050	3450	3200	3200	3150	3050	3050
4.5		Height of mast, extended	h4 (mm)	3813	3813	3826	4113	3975	3978	3813	3825	3823
4.7		Height of overhead guard (cabin)	h6 (mm)	2080	2080	2080	2237	2237	2237	2080	2080	2080
4.8		Height of seat/stand-on platform	h7 (mm)	1002	1002	1002	1160	1160	1160	1002	1002	1002
4.12		Towing coupling height	h10 (mm)	621	621	623	656	658	656	624	622	626
4.19		Overall length	l1 (mm)	3318	3318	3444	3352	3375	3383	3463	3539	3594
4.20		Length to fork face	l2 (mm)	2318	2318	2444	2352	2375	2383	2463	2539	2594
4.21		Overall width	b1/b2 (mm)	1150 / 1148	1150 / 1148	1150 / 1178	1150 / 1146	1150 / 1146	1228 / 1146	1150 / 1148	1150 / 1148	1322 / 1178
4.22		Fork dimensions	s/e/l (mm)	45 x 100 x 1000	45 x 100 x 1000	45 x 100 x 1000	45 x 100 x 1000	45 x 100 x 1000	50 x 120 x 1000	45 x 100 x 1000	45 x 100 x 1000	50 x 120 x 1000
4.23		Fork carriage to ISO 2328, class/type A, B		2A	2A	3A	2A	2A	3A	2A	3A	3A
4.24		Width of fork carriage	b3 (mm)	1080	1080	1150	1080	1150	1150	1080	1150	1150
4.31		Ground clearance, below mast	m1 (mm)	130	129	136	130	127	136	130	136	129
4.32		Ground clearance, centre of wheelbase	m2 (mm)	120	120	120	120	120	120	120	120	120
4.33		Aisle width with pallet 1000 x 1200 across forks	Ast (mm)	3638 ²⁾	3638 ²⁾	3762 ²⁾	3672 ²⁾	3693 ²⁾	3700 ²⁾	3783 ²⁾	3857 ²⁾	3911 ²⁾
4.34		Aisle width with pallet 800 x 1200 along forks	Ast (mm)	3766 ²⁾	3766 ²⁾	3891 ²⁾	3800 ²⁾	3822 ²⁾	3830 ²⁾	3911 ²⁾	3986 ²⁾	4041 ²⁾
4.35		Turning radius	Wa (mm)	1873	1873	1973	1907	1907	1907	2018	2068	2118
4.36		Minimum pivoting point distance	b13 (mm)	0	0	0	0	0	0	0	0	0
Performance	5.1	Travel speed, with/without load	(km/h)	20 / 20	20 / 20	20 / 20	20 / 20	20 / 20	20 / 20	20 / 20	20 / 20	20 / 20
	5.2	Lifting speed, with/without load	(m/s)	0.45 / 0.56	0.45 / 0.56	0.42 / 0.51	0.45 / 0.56	0.44 / 0.53	0.42 / 0.51	0.45 / 0.56	0.42 / 0.51	0.39 / 0.51
	5.3	Lowering speed, with/without load	(m/s)	0.54 / 0.54	0.54 / 0.54	0.56 / 0.56	0.54 / 0.54	0.56 / 0.56	0.56 / 0.56	0.54 / 0.54	0.56 / 0.56	0.56 / 0.56
	5.5	Tractive force, with/without load	(N)	4600 / 4600	4600 / 4600	4600 / 4600	4600 / 4600	4600 / 4600	4600 / 4600	4600 / 4600	4600 / 4600	4600 / 4600
	5.6	Maximum tractive force, with/without load	(N)	15000 / 15000	15000 / 15000	15000 / 15000	15000 / 15000	15000 / 15000	15000 / 15000	15000 / 15000	15000 / 15000	15000 / 15000
	5.7	Climbing ability, with/without load	(%)	7.6 / 11.2	6.5 / 10.0	5.6 / 8.8	6.9 / 9.8	5.9 / 8.7	5.3 / 8.0	6.6 / 10.3	5.6 / 8.8	5.1 / 8.2
	5.8	Maximum climbing ability, with/without load	(%)	25.4 / 39.0	21.6 / 34.1	18.7 / 30.0	23.0 / 33.4	19.7 / 29.3	17.5 / 27.0	22.1 / 35.4	18.6 / 29.7	16.8 / 27.8
	5.9	Acceleration time, with/without load	(s)	upon request	upon request	upon request	upon request	upon request	upon request	upon request	upon request	upon request
	5.10	Service brake		hydr./mech.	hydr./mech.	hydr./mech.	hydr./mech.	hydr./mech.	hydr./mech.	hydr./mech.	hydr./mech.	hydr./mech.
	Drive	6.1	Drive motor, 60 minute rating	(kW)	2x 9	2x 9	2x 9	2x 9	2x 9	2x 9	2x 9	2x 9
6.2		Lift motor rating at 53 15%	(kW)	22	22	22	22	22	22	22	22	22
6.3		Battery according to DIN 43531/35/36 A,B,C,no		43 536 / A	43 536 / A	43 536 / A	43 536 / A	43 536 / A	43 536 / A	43 536 / A	43 536 / A	43 536 / A
6.4		Battery voltage/rated capacity (5h)	(V/Ah)	80 / 460-500	80 / 460-500	80 / 460-500	80 / 560-620	80 / 560-620	80 / 560-620	80 / 575-625	80 / 575-625	80 / 575-625
6.5		Battery weight (± 5%)	(kg)	1210	1210	1210	1558	1558	1558	1458	1458	1458
6.6		Power consumption according to VDI cycle	(kWh/h)	6,4	7,5	8,6	7	7,9	8,7	7,3	8,6	9,5
Others	8.1	Type of drive control		Digital/stepless	Digital/stepless	Digital/stepless	Digital/stepless	Digital/stepless	Digital/stepless	Digital/stepless	Digital/stepless	Digital/stepless
	8.2	Operating pressure for attachments	(bar)	170	170	170	170	170	170	170	170	170
	8.3	Oil flow for attachments	(l/min)	50	50	50	50	50	50	50	50	50
	8.4	Noise level at operator's ear	(dB(A))	<65.0	<65.0	<65.0	<65.0	<65.0	<65.0	<65.0	<65.0	<65.0

1) Figures with battery, see line 6.4/6.5.

2) Including a 200 mm (min.) operating aisle clearance.